

Canon EF  
EX

*A BFA*



English Edition

We are highly gratified that you have selected the Canon EX EE—a wise choice that promises you many delightful years of photographic experiences. Canon is recognized the world over as the foremost pioneer in the development of photographic equipment of the highest quality and performance. Whether your new EX EE is for the home or for traveling, make the most of your opportunities!

### **Before Using . . .**

Please read this instruction booklet carefully, and master the manipulations of the various parts of the EX EE completely. Once thoroughly versed in the correct handling of this camera, you can use the Canon EX EE to the fullest extent of its capabilities



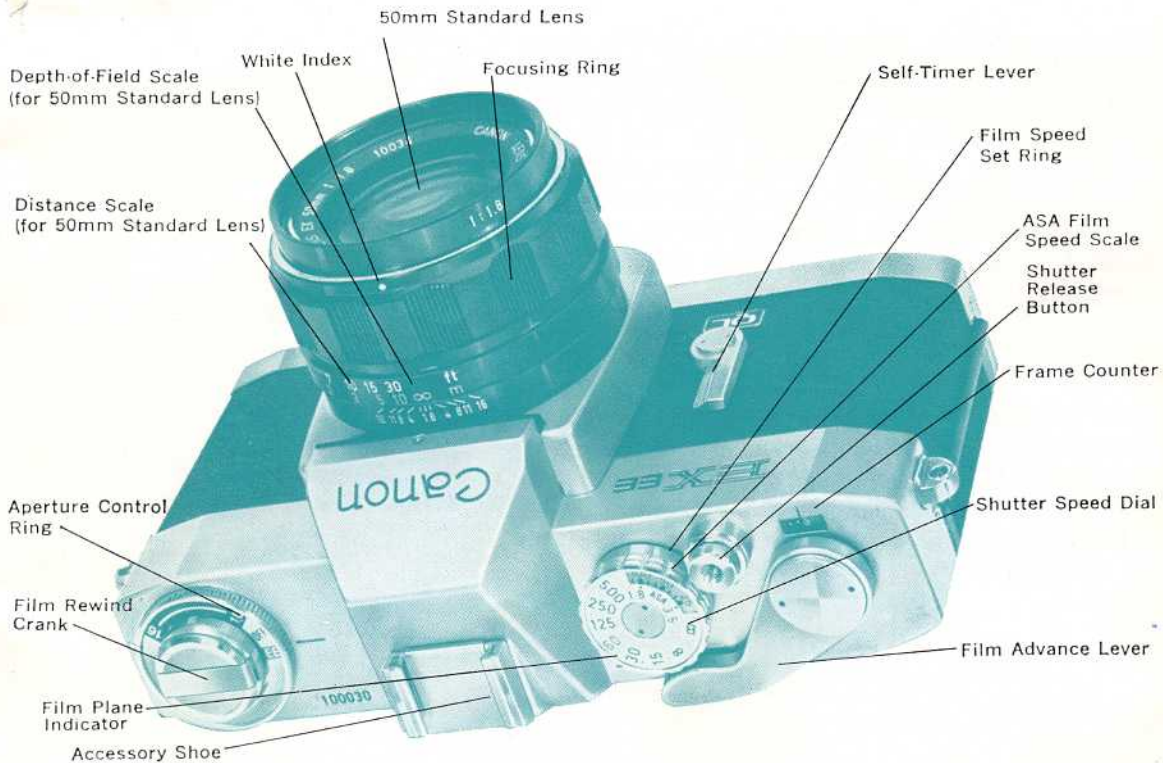



## Technical Data

- Type: 35mm single-lens reflex camera with Electric Eye.
- Lens: Front component convertible type with thread mount. EX 50mm F 1.8 (standard), EX 35mm F 3.5 (wide-angle), EX 95mm F 3.5 (telephoto) and EX 125mm F 3.5 (telephoto).
- Viewfinder: Eye-level using pentagonal prism. Aerial image type. 50mm lens has magnification of 0.9x. Combined with micropism screen rangefinder. Contains exposure indicator, f/stop scale and over/under exposure warning marks. Waist-Level Viewer 2 can be attached.
- Mirror: Shockless quick return system.
- Shutter: Cloth focal-plane shutter with speeds from 1/500 to 1/8 sec. and B. X contact at 1/60 sec. Single pivot dial.
- Electric Eye Mechanism: Fully coupled to film speed, shutter speed dial and aperture setting. Shutter speed priority system. Diaphragm closes down to proper f/stop by depressing shutter release button. With F 1.8 lens, ASA 25-800. With F 3.5 lens, ASA 25-500. Film speed is set by turning film speed set ring at index of lens to be used. With ASA 100 film, EV 4.7 (f/1.8 at 1/8 sec.)—EV 17 (f/16 at 1/500 sec.). Powered by one 1.3 v M20 (#625) mercury battery.
- Light Measurement: Through-the-lens (TTL) system. CdS photocell just above the eyepiece measures light passing through taking lens in fully opened condition. Measures total picture area with emphasizing higher sensitivity at central section.
- Manual Control of Aperture: Pre-set possible at any desired f/stop by releasing EE mechanism and turning the aperture control ring.
- Flash Synchronization: X contact. Synchronizing possible for FP, M and MF flash bulbs and electronic flash units.
- Film Rewinding: By button and crank.
- Film Advance Lever: 174° single operation. Possible to wind with several short strokes.
- Self-Timer: Built-in. Charged self-timer starts to actuate by depressing shutter release button.
- Film Loading: By opening back cover. Back cover lock released by pulling up film rewind crank. Accepts any 35mm film roll in cartridge. QL mechanism for quick loading of film.
- Frame Counter: Self-resetting.
- Size: 143 x 92 x 84mm (5<sup>5</sup>/<sub>8</sub>" x 3<sup>5</sup>/<sub>8</sub>" x 3<sup>1</sup>/<sub>4</sub>").
- Weight: 900 grams (1 lb. 15<sup>3</sup>/<sub>4</sub> oz.)—with 50mm standard lens.

Subject to alterations

# Contents

Mercury Battery Loading and Checking . . . . .	8
Film Loading . . . . .	11
Film Winding . . . . .	13
Film Speed Setting . . . . .	14
Photography with Electric Eye . . . . .	14
Shutter Speed Adjustments . . . . .	15
Focusing . . . . .	16
Composition . . . . .	17
Checking the Exposure Indicator . . . . .	18
Camera Holding and Shutter Release . . . . .	20
Film Rewinding . . . . .	22
Manual Control of Aperture . . . . .	23
Uses of Lenses . . . . .	25
Using Self-Timer . . . . .	29
Attaching the Cable Release . . . . .	29
Synchronizing Flash Unit . . . . .	30
Double Exposures . . . . .	31
Filters . . . . .	32
Interchangeable Lenses and Accessories . . . . .	33
Proper Care of the Camera . . . . .	35

# Follow these simple steps for normal photography with Electric Eye:

- 1** Load the film simply with the QL mechanism.
- 2** Set the ASA film speed to the index of the lens to be used.
- 3** Wind the film advance lever.
- 4** Turn the aperture control ring to "EE".
- 5** Select your desired shutter speed.

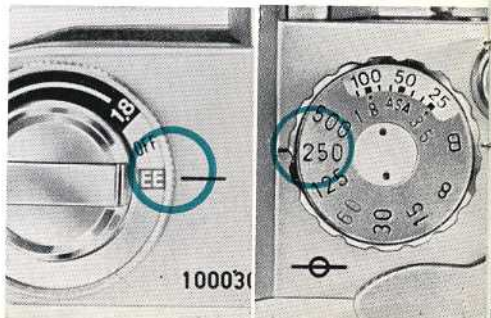
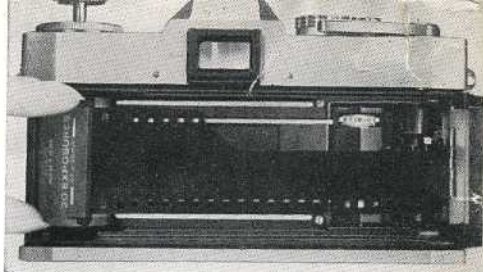



**6** Remove the lens cap.



**7** Look through the viewfinder and focus.

**8** Compose the picture.

**9** Check whether the exposure indicator is within the proper range.

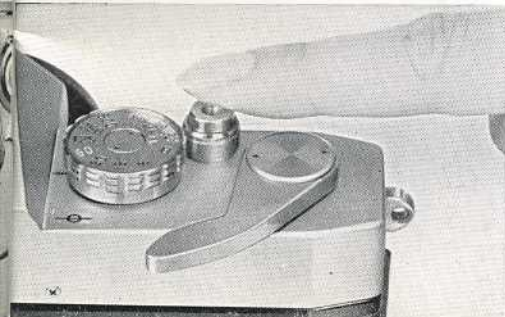

**10** Depress the shutter release button gently.



## Mercury Battery Loading and Checking

Before using your Canon EX EE, load it with the mercury battery packed in a separate envelope. The Electric Eye functions only when the battery is properly loaded.

- 1** Insert a coin into the groove of the battery compartment cover and turn to the left to remove.
- 2** Face the central contact of the mercury battery inwards and insert.
- 3** Replace the cover by turning it to the right.

■ Before inserting, wipe all battery poles clean of fingerprints or stains with a dry cloth. Unclean poles may cause corrosion and damage the contact points of the camera.

■ A 1.3 v M20 (#625) mercury battery should be used—equivalent to Mallory PX-625, Eveready EPX-625.

■ Be sure to insert the battery in the correct direction by referring to the diagram on the compartment cover. Otherwise, the Electric Eye will not function properly and the cover cannot be screwed in.

■ When the camera is not used for a long period, remove the mercury battery and keep in a dry place.

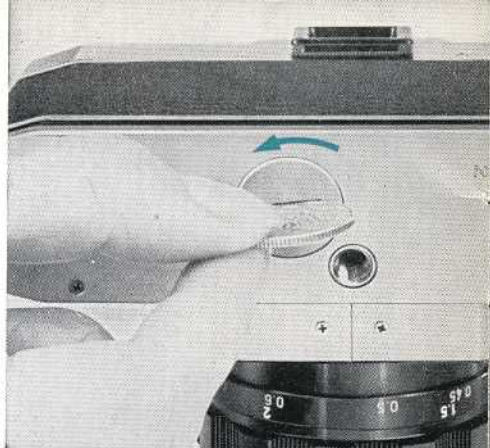



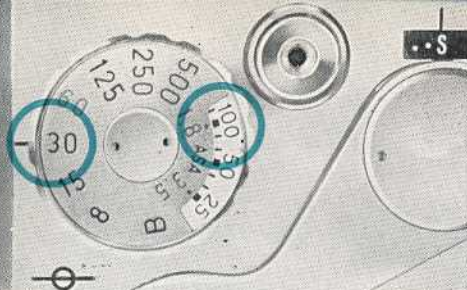

## Battery Check

To check the power level of the mercury battery :

**1** Set the film speed scale at ASA 100, the shutter speed dial at the "30" index. For the film speed setting, lift up the outer ring of the shutter speed dial and turn.

**2** Turn the aperture control ring to "EE" and aim the camera at the sky or other bright subject. If the exposure indicator inside the viewfinder swings up to or over the "16" index, the battery has sufficient power. Otherwise, the battery must be replaced.

■ Life of the battery in normal use is approximately one year. It is advisable to replace the battery when one year passes after loading.

■ The battery releases current only when the aperture control ring is set at "EE".

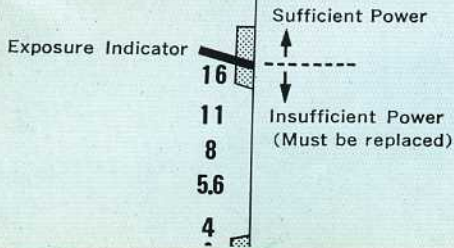
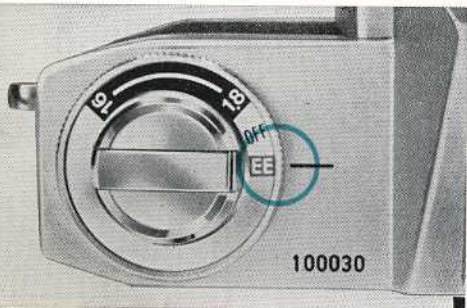

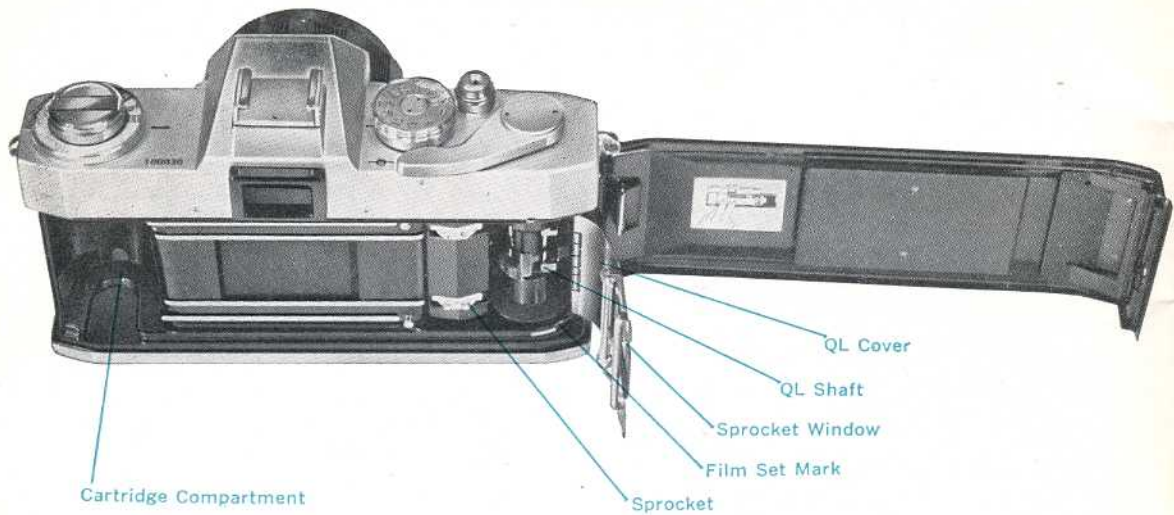

Cartridge Compartment

QL Cover

QL Shaft

Sprocket Window

Film Set Mark

Sprocket

Direction in which film is placed  
(emulsified surface facing the back of the lens)



## Film Loading

The Canon EX EE accepts any standard 35mm film roll in cartridge for daylight loading. When loading a new film, always avoid direct sunlight.

- 1** Raise the film rewind crank and pull it all the way up. The cover will rise slightly.
- 2** Open the cover fully. When the back cover is opened, the QL cover opens simultaneously.
  - The QL cover automatically opens and closes with the back cover. Do not touch the QL cover.
- 3** Face the film cartridge as illustrated, and insert it into the cartridge compartment. Push the crank back to its former position again. The crank fork will slip into the axis of the film cartridge. In case the crank does not fully return, turn it slightly to the left or right.
- 4** Hold the film cartridge down with the left hand so that it does not rise, and lay the tip of the leader above the "red" film set mark.

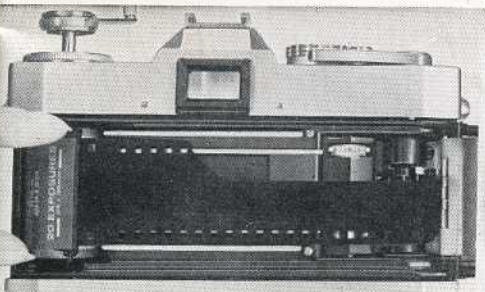
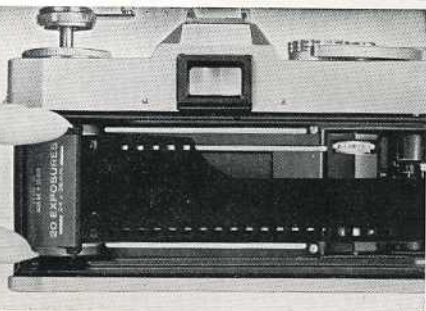

**5** Bring down the QL cover to hold the film in place by closing the back cover. Look through the sprocket window to see if the film is correctly engaged on the sprocket.

**6** Close the back cover by pressing down on the cover.

■ If the film is sagging, the cartridge will rise and the back cover will not close.

**7** Leave the lens cap on and make three blank shots, each time turning the film advance lever. The frame counter will advance from the "S" mark to "0". With one more advance, the camera will be ready for the first shot.

■ When repacking a long-wound film for darkroom loading into an ordinary cartridge, be sure to trim the tip of the leader between perforations.

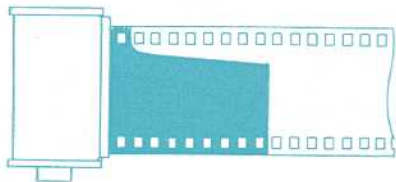

### Checking Correct Film Loading

The film is properly loaded and advanced if the film rewind crank rotates when you wind the film advance lever. If the rewind crank does not rotate, take out the film, as explained on the following page, and reload.

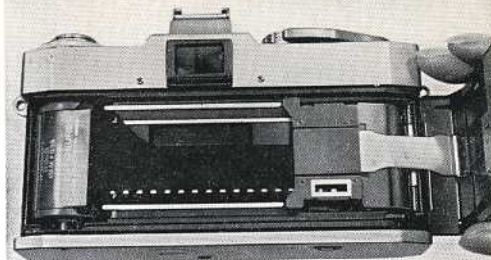



## Film Winding

The film advance lever winds the film, cocks the shutter, and prepares the mirror for the next shutter release all in one motion.

**1** Turn the film advance lever until it stops. The film will be advanced one frame and the shutter cocked. The frame counter is simultaneously advanced to the next number.

**2** When the shutter release button is depressed, the mirror flips up, the diaphragm simultaneously closes down to the proper f/stop (in case of manual control, to the pre-set f/stop) and the shutter operates. After the shutter is operated, the advance lever can be wound for the next frame.

- Winding may be done by moving the lever with several short strokes.
- After loading the film, make another wind, since the first winding may not be completed.
- The shutter will not function when depressing the shutter release button unless the winding is completed. In such a case, check the winding once more.

## Frame Counter

Each winding will advance the number of the frame counter, indicating the number of pictures taken. When the back cover is opened, the indicator automatically returns to starting position "S".

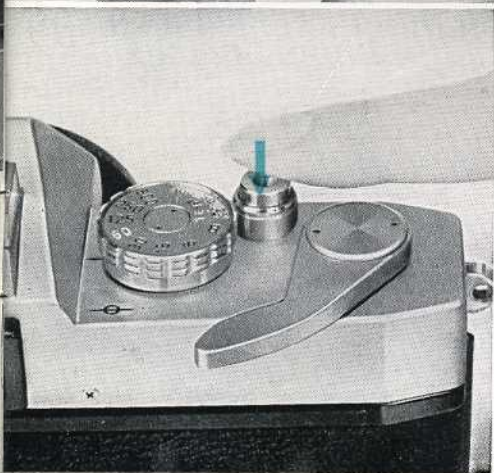
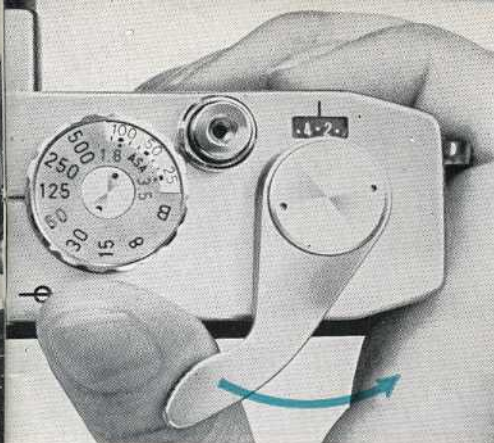

## Film Speed Setting

When loading the film, be sure to set the film speed scale at the proper position.

Lift the film speed set ring around the shutter speed dial, and match the proper ASA film speed number with the index of the lens to be used. If the film is ASA 100 and lens being used is the 50mm F 1.8 for example, make the correct setting by matching "100" with the "1.8" index.

The setting should be adjusted whenever replacing the lens with a different lens speed. Otherwise, the proper exposure cannot be obtained.

■ ASA 25-800 with the 50mm F 1.8 lens, and ASA 25-500 with the 35mm, 95mm or 125mm F 3.5 lens, may be used.

ASA 25 · · 50 · · 100 · · 200 · · 400 · · 800

(32) (40) (64) (80) (125) (160) (250) (320) (500) (640)

Figures in parentheses represent intermediate film speeds.

## Photography with Electric Eye

For taking pictures with Electric Eye, set the aperture control ring at "EE".

■ The Electric Eye is fully coupled to the ASA film speed, the shutter speed and the aperture. The diaphragm will close down to the proper f/stop and exact exposure is determined by simply depressing the shutter release button.

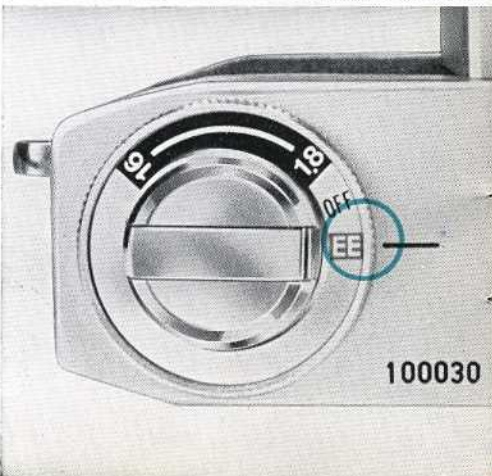

## Shutter Speed Adjustment

Adjust the shutter speed by turning the shutter speed dial to the desired index number. The index on the dial shows the denominators of 1/500 sec., 1/250 sec., etc.

- Be sure to set the index at a position where the click-stop catches.

- "B" indicates bulb exposure, and is used when making indefinite timed exposures. When the shutter speed dial is set at "B", the shutter remains open as long as the shutter release button is depressed.

- Time exposure, making an exposure over an extended time, is possible by using the lockable cable release and setting the shutter speed dial at "B".

- The "60" index is used for synchronizing an electronic flash unit such as the Canon Speedlite 102. Although the shutter speed at "60" is 1/60 sec., it is equivalent to a very short exposure time during the flash of the electronic flash unit.

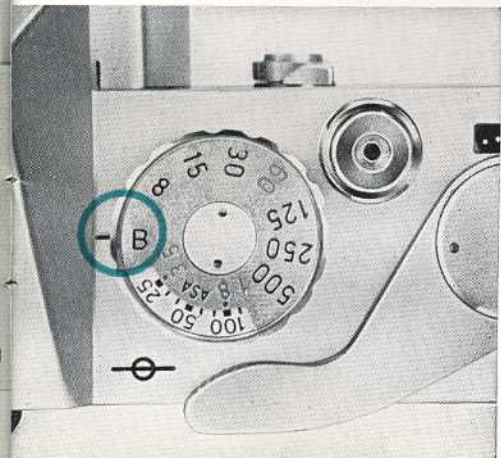
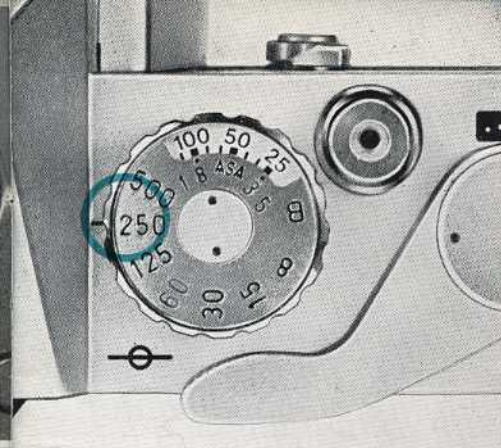



## Focusing

The center of the viewfinder (circular section) is a micro-prism screen rangefinder made up of microscopic prisms for fast and precise focusing.

While looking through the viewfinder, rotate the focusing ring. It is in focus when the image in the rangefinder becomes sharp and clear.

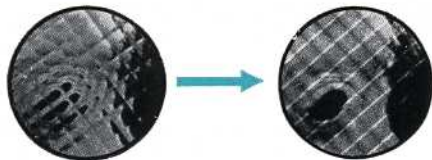

Out of Focus

In Focus



Focusing Ring

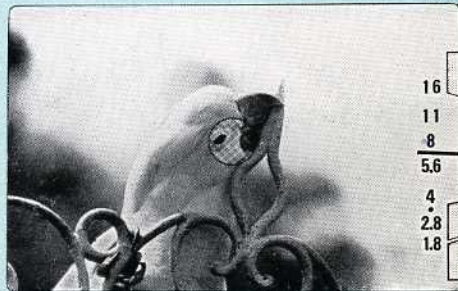



## Composition

The exact picture image to be photographed can be clearly seen through the viewfinder without any parallax. This enables you to determine the exact composition of your scene before depressing the shutter release button.

■ Canon Angle Finder A can be attached to the eyepiece for copying and close-up photographs. In these cases, images are reversed between left and right.

■ Dioptic adjustment lenses are available as optional attachments. When a dioptic adjustment lens is attached to the viewfinder eyepiece, those who are far- or near-sighted can take pictures without glasses. Four different diopters of +1.5, 0, -2.5 and -4 are available.



## Checking the Exposure Indicator

Turn the aperture control ring to "EE". Point the camera at the subject and check the position of the exposure indicator inside the viewfinder.

**1** You may depress the shutter release button if the indicator is pointing inside the proper exposure range.

**2** If the indicator is pointing to the over-exposure warning mark, either the shutter speed dial should be revolved to the higher index side until the indicator moves to the proper exposure range, or a neutral density (ND) filter must be attached to restrict the incoming light.

**3** If the indicator is pointing to the under-exposure warning mark, either the shutter speed dial should be revolved until the indicator moves to the proper exposure range, or light source must be increased.

■ Upper splitted part of the under-exposure warning mark applies only to the F3.5 lenses, i. e., the 35mm wide-angle, 95mm and 125mm telephoto lenses.

■ The Electric Eye mechanism functions only when the aperture control ring is set at "EE".

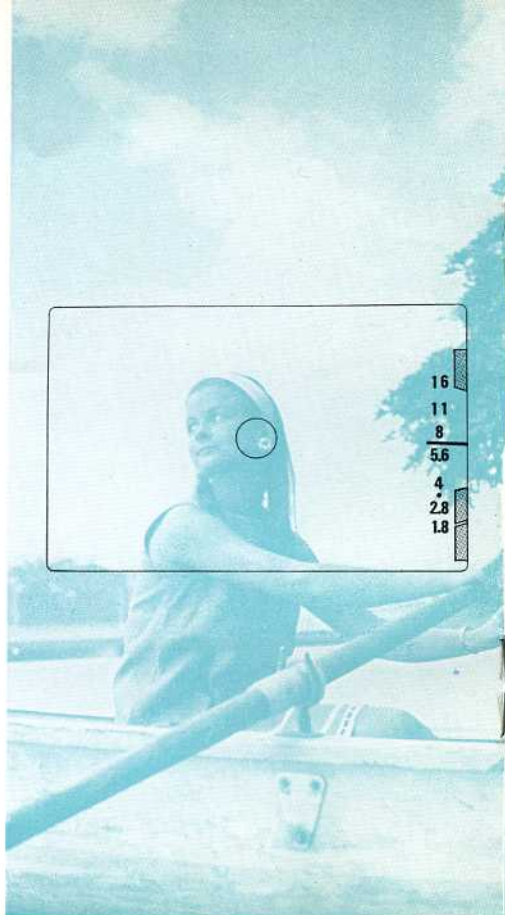



## Coupling Range of the Electric Eye

The Electric Eye couples to the following range of f/stops and shutter speeds with respective film speeds. When using the 50mm standard lens and ASA 100 film, for example, the Electric Eye couples fully within the range of f/1.8 at 1/8 sec. and f/16 at 1/500 sec.

- The Electric Eye does not function at "B" of the shutter speed dial because "B" is used for indefinite timed exposures.
- When the Electric Eye is outside the coupling range, the exposure indicator will point to the under-exposure warning mark, and will indicate that proper exposure cannot be obtained.

ASA Film Speeds	With F 1.8 Lens (50mm)		With F 3.5 Lens (35, 95 or 125mm)	
	Shutter Speeds	f/Stops	Shutter Speeds	f/Stops
25-40	1/8-1/125 1/250	f/1.8-16 f/3.5-16	1/8-1/250 1/500	f/3.5-16 f/3.5-11
50	1/8-1/250 1/500	f/1.8-16 f/3.5-16	1/15- 1/500	f/3.5-16
64-100	1/8-1/500	f/1.8-16	1/30- 1/500	f/3.5-16
125-200	1/15- 1/500	f/1.8-16	1/60- 1/500	f/3.5-16
250-400	1/30- 1/500	f/1.8-16	1/125- 1/500	f/3.5-16
500	1/60- 1/500	f/1.8-16	1/250- 1/500	f/3.5-16
640-800	1/60- 1/500	f/1.8-16	—	—



## Camera Holding and Shutter Release

Hold the camera firmly in order to take a clear picture. Hold the camera either in a vertical or horizontal position, look through the viewfinder, and focus. Then press the shutter release button gently. The following steps are important.

- 1** Hold the camera snugly in both hands. The camera should be pressed firmly to your cheek or forehead.
- 2** When the camera is in a horizontal position, both elbows should be firmly pressed against the body, and at least one elbow should be resting against the body when in a vertical position.
- 3** Hold your breath and press the shutter release button with a smooth, steady stroke. Otherwise, you will have a blurred picture.
  - When using slow shutter speeds below 1/30 sec, the use of a tripod and cable release is recommended.
  - When taking pictures against the light, always use a lens hood.

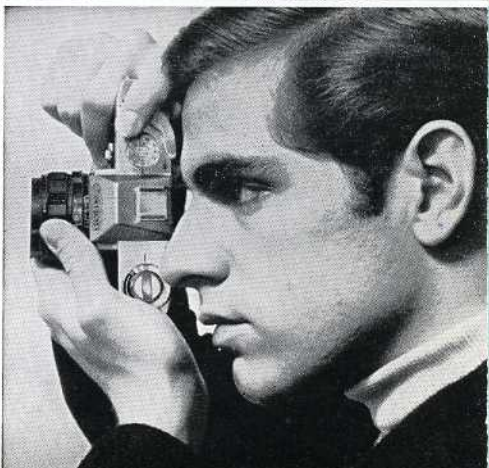



## Relationship Between the Shutter, Diaphragm, and Mirror

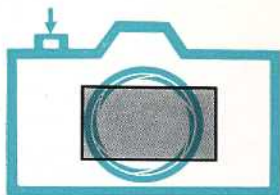

Press the shutter release button.



The diaphragm closes down to the f/stop designated by Electric Eye and the shutter clicks.



The diaphragm returns to maximum opening.



Mirror begins to snap up.



Mirror is up.



Mirror returns to former position.

## Film Rewinding

When the film reaches the end and the film advance lever stops, rewind the film into the cartridge as soon as possible. Be sure not to open the back cover before rewinding. Otherwise, the entire roll will be exposed and ruined as the exposed film is naked within the camera.

- 1 Press in the rewinding button.
  - 2 Raise the film rewind crank, turn it in the direction of the arrow, and rewind the film into the cartridge. When the rewinding button stops revolving and rewinding resistance becomes light, stop rewinding immediately.
  - 3 Open the back cover by pulling up the rewind knob fully.
  - 4 Remove the cartridge.
- Once the rewinding button has been pressed, the finger may be removed. The button will pop out automatically when the film advance lever is wound.
  - If you force the film advance lever after the film reaches its end, the film will become detached from the cartridge spool or tear, and rewinding will become impossible. If this happens, open the back cover and remove the film only in a darkroom.



## Manual Control of Aperture

Incoming light and depth-of-field can be manually controlled by turning the aperture control ring to the direction of "1.8-16". The exposure indicator in the viewfinder moves to indicate the pre-set f/stop. Use this method when using the flash unit, photographing in counter-lighted situation, or stressing high-key/low-key effects.

■ The diaphragm will close down to the pre-set f/stop only for the instant that the shutter is released. Except for that instant, the diaphragm remains fully open.

■ As the f/stop value gets larger, the amount of light reaching the film plane becomes correspondingly less. For each f/stop up, the light is reduced one-half. Accordingly, when the aperture is increased by one f/stop, the exposure is doubled, and when it is increased by two f/stops the exposure is quadrupled.

■ The ratio between the aperture and the amount of exposure, using f/2 as the basis, is as follows:  
f/stop:

1.8   2   2.8   3.5   4   5.6   8   11   16

Exposure Ratio:

1.25   1   1/2   1/3   1/4   1/8   1/16   1/32   1/64

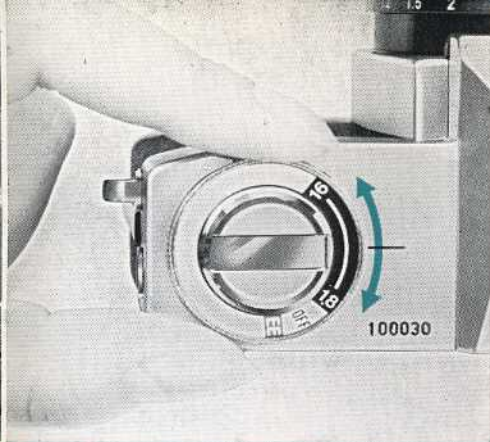



125mm Telephoto Lens



95mm Telephoto Lens



50mm Standard Lens



35mm Wide-Angle Lens





## Uses of Lenses

The lenses are of the front component convertible type. The rear component of the optical system and diaphragm are built into the camera body.

### Changing Lenses

- 1** Remove the front component of the lens by turning it counterclockwise.
  - 2** Set the infinity mark ( $\infty$ ) of the distance scale for the standard lens on the camera body side at the orange line indicator. Turn the focusing ring clockwise as far as possible.
  - 3** Mount the lens to be replaced by turning clockwise until it is securely in place.
  - 4** Adjust the film speed scale whenever replacing the lens with a different lens speed. Refer to page 14 for setting the film speed.
- Attach the lens quickly in the shade. The film will sometimes become foggy if the lens is left unattached.
  - Whenever a lens is removed, be sure to put on its lens cap and dust cap.

## Setting Distance Scale of 35mm, 95mm and 125mm Lenses

When using the 35mm wide-angle, 95mm or 125mm telephoto lens, be sure to set its distance scale on the front component properly.

**1** After replacing the lens, set the infinity mark ( $\infty$ ) of the distance scale for the standard lens on the camera body side at the orange line indicator.

**2** Rotate the distance scale on the front component and set the infinity mark ( $\infty$ ) of the distance scale for the 35mm, 95mm or 125mm lens at the white index on the focusing ring.

**3** Set the focus by turning the focusing ring. Read the distance scale on the front component with the white index.

■ When using the 95mm or 125mm lens, focus precisely since the depth-of-field is shallow.

■ Be sure not to turn the adjusted distance scale on the front component. If the position of the distance scale is moved, correct distance cannot be read off.

### Distance Scale

The distance scale indicates the distance between the focused subject and the film plane. The scale is used for checking the depth-of-field, for flash and infrared photographs.

■ The correct position of the scale is in the center of each value. For example, the correct position of a two-digit value is the center of the two figures.

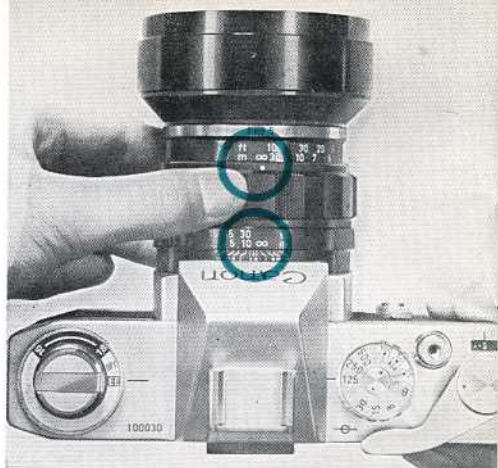



### 50mm Lens f/8

Depth-of-field 2.3m-4.3m (8'-14')

Focused at 3m (10')



### 50mm Lens f/16

Depth-of-field 1.9m-7.6m (6'-25')

Focused at 3m (10')

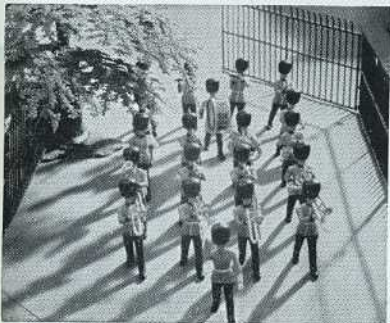

## Depth-of-Field Scale

The depth-of-field scale which is applicable when using the 50mm standard lens, indicates the range of subjects which will be in focus sharply on the film. This range will vary with the following factors: The depth-of-field will be deeper the smaller the aperture opening, the further the distance of the subject, and/or the shorter the lens focal length. The depth-of-field will be shallower the larger the aperture opening, the nearer the distance of the subject, and/or the longer the lens focal length. For example, if the 50mm standard lens is used and the subject has been focused at a distance of 3m (10'), with an f/8 aperture value read off from both indexes on either side of the indicator (orange line), the depth-of-field is from approximately 2.3m (8') to 4.3m (14'). If the aperture is closed down to f/16, the picture will become sharp between 1.9m (6') to 7.6m (25') from the camera. This range will vary with the f/stop selected.



## Infrared Photography

For infrared photography, correction of the distance scale is necessary because the focal point slightly deviates from ordinary photography. When using the 50mm standard lens, focus first in the ordinary manner, then adjust the distance scale to the infrared mark "R". For instance, if the distance scale reads at 10m after focusing, merely shift the "10" scale to "R" position. When using the 35mm wide-angle, the 95mm or the 125mm telephoto lens, focus first in the ordinary manner, then shift the focusing ring counterclockwise 2.1mm (1/16") and 3.5mm (1/8") respectively.

■ The correction is based on using film with the highest wave-length sensitivity figure of 800m $\mu$ , such as Kodak IR 135 film and Wratten 87 filter.

## Film Plane Indicator

When the focusing is done by actual measurement, read the distance from the film plane indicator and interpret the measured distance on to the distance scale.

■ Although air bubbles may sometimes be seen in a lens, they do not affect the resolving power or the sharpness of the picture.

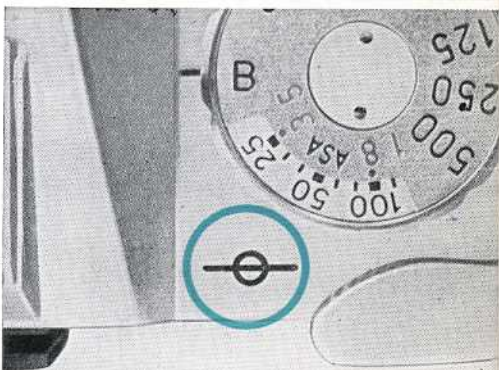



## Using Self-Timer

- 1 Wind the film advance lever.
  - 2 Turn the self-timer lever counterclockwise until it stops.
  - 3 Depress the shutter release button. The shutter will be actuated approximately 10 seconds later.
- Be sure to wind the film advance lever. Otherwise, the self-timer will act but the shutter will not be actuated.

## Attaching the Cable Release

Separately available Canon Release can be attached to the EX EE by screwing it into the threaded hole in the center of the shutter release button.

- Be sure to attach the cable release before winding up the film advance lever. Otherwise, the shutter may be inadvertently operated by screwing it into the socket.

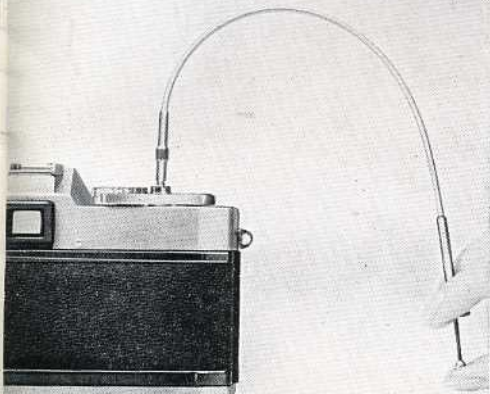

## Synchronizing Flash Unit

By connecting the cord of the flash bulb unit or the electronic flash unit to the flash socket, synchronization becomes possible with the following shutter speeds.

■ A lens hood should be attached when taking pictures with a flash unit.

Type		Synchronized Shutter Speeds
Flash Bulb	FP class (# 6, Press 26)	1/15 or slower
	M class (M 3, # 5, Press 25)	1/15 or slower
	MF class (AG-1, AG-3, M2, Flashcube)	1/15 or slower
Electronic Flash Unit	Speedlite	1/60 or slower







## Double Exposures

Although Canon EX EE is designed to prevent double exposures being made by mistake, a double exposure can be done by the following steps:

- 1** When the first exposure has been made, depress the rewinding button.
  - 2** Rewind the film with the rewinding crank by watching the mark on the rewinding button carefully.
  - 3** Stop rewinding when the mark has made a 3/4 turn, i.e., 270°.
  - 4** Next, wind the film advance lever while lightly holding the rewinding crank. When resistance is felt on the rewinding crank, stop winding.
  - 5** Wind the film advance lever once more. The camera is ready for another exposure.
- By repeating the above process, any number of exposures on the same frame can be made. The frame counter will, however, continue to advance with each exposure.

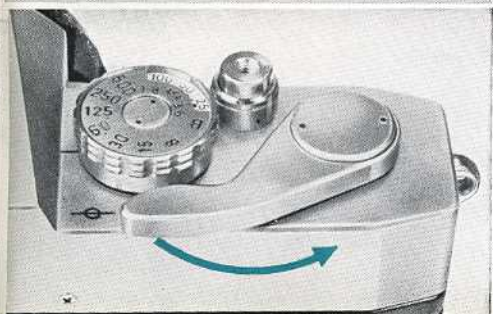

# Filters

Type	Effectiveness of Filters
○● UV	Absorbs only ultra-violet rays. Especially effective at seaside, and in high mountains. Recommended for use in color photography.
○ Y1*	Increases contrast of black and white film. Enhances clouds, darkens the blue sky. Brightens red and yellow.
○ Y3	
○ O1*	Darkens blue, increases yellow and red perceptibly. Good for contrasts especially in distant landscapes.
○ R1	Makes strong contrasts. May also be used with infrared film.
○ G1*	Prevents red from turning radically into white. Lightens sky and face appropriately, and reflects the lightness of fresh greenery.
○● ND4	ND4 reduces light values by 1/4, ND8 by 1/8. No effect on the reproduction of colors.
○● ND8	
● SKYLIGHT	Acts to harmonize the blue sky and shade.
● CCA 4 *	For use with daylight type film under the cloud.
● CCA 8 *	For use with universal type (color negative) film under the cloud or tungsten type film under the morning sun or sunset.
● CCA (12 equiv.)	For use with tungsten type film under sunlight.
● CCB 4 *	For use with daylight type film under the morning sun or sunset.
● CCB 8 *	For use with daylight type film and clear flash bulb.
● CCB (12 equiv.)	For use with daylight type film under tungsten light.

○ For black and white film. ● For color film.

\* For 48mm filter only.

Various types of 48mm and 62mm screw-in type filters are available for special effects in both color and black and white photography. Through-the-lens exposure measurement system of the Canon EX EE does not require exposure factor compensation.

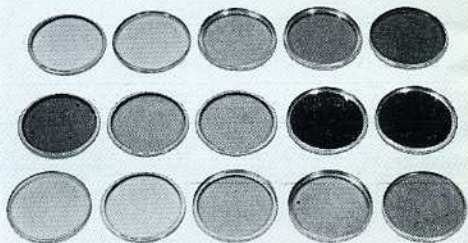

# Interchangeable Lenses and Accessories

High performance EX series lenses with the most often used focal lengths and various accessories are available to further enhance your Canon EX EE.

## Interchangeable Lenses

- EX 50mm F 1.8 (Standard)
- EX 35mm F 3.5 (Wide-angle)
- EX 95mm F 3.5 (Telephoto)
- EX 125mm F 3.5 (Telephoto)

## Accessories

- Flash V-3
- Flash J-3
- Angle Finder A
- Magnifier S
- Dioptric Adjustment Lenses
- Filters (48mm, 62mm and 72mm screw-in type)
- Lens Hood for EX 50mm F1.8 (S-50)
- Lens Hood for EX 35mm F3.5 (W-50)
- Lens Hood for EX 95mm F3.5 (T-65)
- Lens Hood for EX 125mm F3.5 (Exclusive)
- 48mm (Close-Up Lenses 240, 450)
- Canon Release 30/50
- Camera Holder F
- Accessory Shoe/Eyepiece Cover
- SLR Eyecup S
- Handy Stand F
- Copy Stand 4

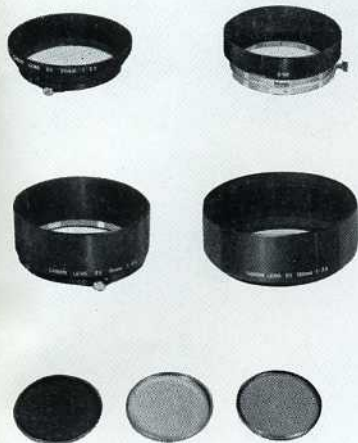



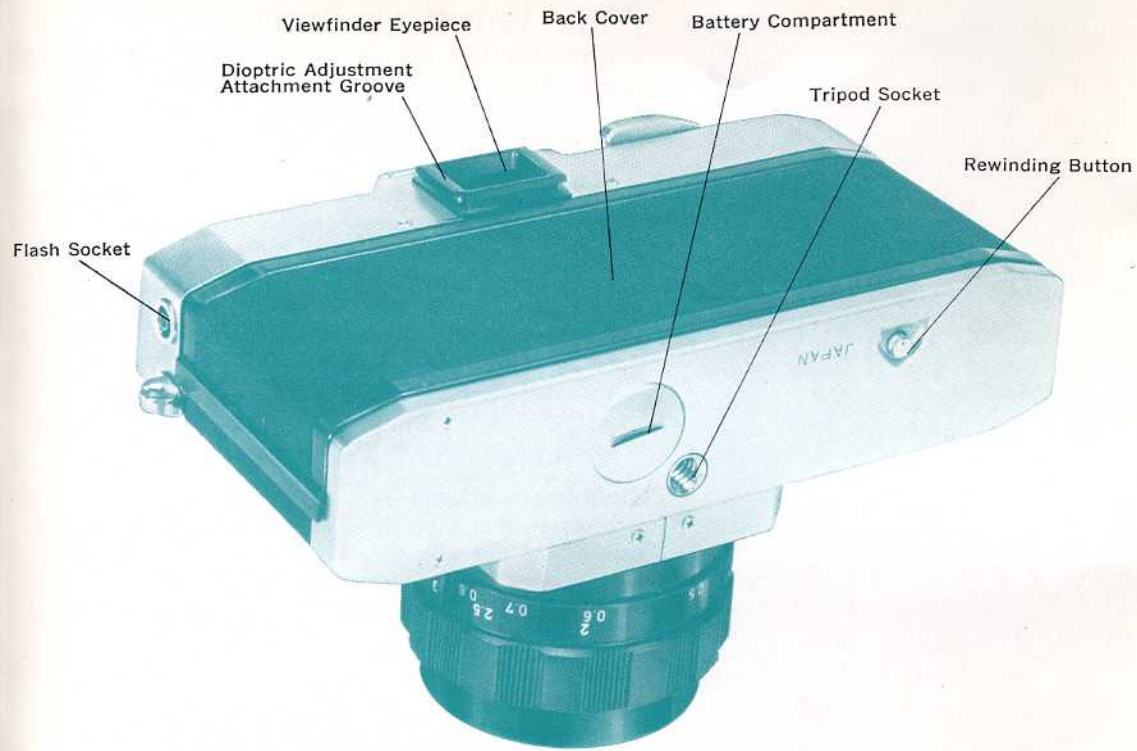

Viewfinder Eyepiece

Back Cover

Battery Compartment

Dioptic Adjustment  
Attachment Groove

Tripod Socket

Rewinding Button

Flash Socket

JAPAN



Camera Body Number \_\_\_\_\_

Lens Number \_\_\_\_\_

Date of Purchase \_\_\_\_\_

Dealer's Name \_\_\_\_\_

## Proper Care of the Camera

Moisture and dust are harmful to your camera. If your camera is to be stored for a long time, it should be removed from its case, and silica gel or another drying agent should be placed alongside it.

When you use your camera on a rainy day, or at the beach, moisture and salt air adhere to it, which can result in stains, rust, and corrosion. Use a soft brush to get rid of dust and a soft dry cloth for wiping.

■ In extremely cold areas, expose the camera to the outer air only when in use. When using, expose the camera gradually to the outer air to prevent the lens from clouding.

■ In hot climates, do not leave the camera inside closed automobiles during the daytime or in direct sunlight. It is not good for the CdS photocell.

### Cleaning the Lens

Use a blower or a brush to remove dust on the lens. If you should get a fingerprint on the lens, soak a little pure alcohol or ether on lens cleaning tissue, then wrap the tissue around a matchstick and wipe the lens lightly in a circular motion.

**CANON INC.**

9-9, Ginza 5-chome, Chuo-ku, Tokyo 104, Japan

**CANON U.S.A., INC.**

10 Nevada Drive, Lake Success, Long Island, N.Y. 11040, U.S.A.

**CANON U.S.A., INC., MANHATTAN SERVICE STATION**

600 Third Avenue, New York, N.Y. 10016, U.S.A.

**CANON U.S.A., INC., CHICAGO OFFICE**

457 Fullerton Avenue, Elmhurst, Illinois 60126, U.S.A.

**CANON OPTICS & BUSINESS MACHINES CO., INC.**

3113 Wilshire Blvd., Los Angeles, California 90010, U.S.A.

**CANON AMSTERDAM N.V.**

Gebouw 70, Schiphol Oost, Holland

**CANON LATIN AMERICA, INC.**

Apartado 7022, Panama 5, Panama